

Turbine Powerhead Operating Instructions

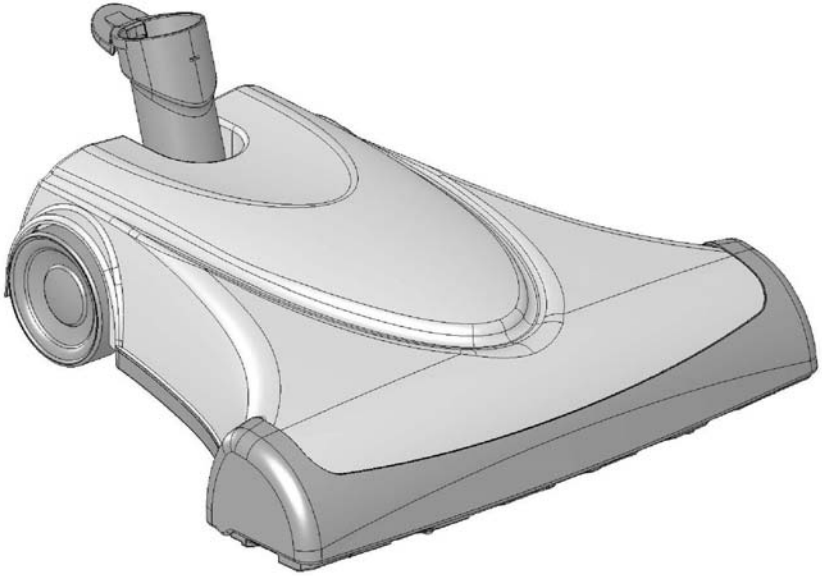

This Turbine Powerhead has been engineered for higher performance, quieter operation and superior cleaning ability. It has been carefully designed and manufactured for long life, reliable performance and convenient cleaning. It requires no electricity because it runs off the airflow of your central vacuum system. The Turbine Powerhead moves easily and does not require downward pressure for thorough cleaning.

Please read and save these Operating Instructions.

SAFETY PRECAUTIONS

As with any tool with moving parts, caution must be exercised while using this Turbine Powerhead.

1. Keep hair, hands and feet away from rotating brush while the Turbine Powerhead is running.
2. Remember that Turbine Powerheads operate whenever they are connected to a running vacuum. If children are present, make sure to turn vacuum system off when leaving Powerhead unit unattended.
3. Do not attempt to service or unclog Turbine Powerhead while unit is running.

Use & Care of Your Turbine Powerhead

(A) ATTACHING THE TURBINE POWERHEAD

To attach your metal wand, simply insert wand into Powerhead neck until it fits snugly. The built-in, locking mechanism will prevent the wand from coming loose. To detach wand, depress wand release tab on back of neck with foot or hand and twist wand free.

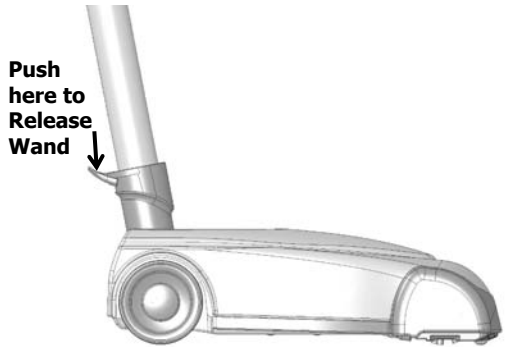

The wand can be locked in an upright position by pushing it forward until the lock is engaged. This locked position is convenient for storage and lifting the Powerhead. To release wand from the vertical locked position, gently place foot on Powerhead, grasp wand and pull back.

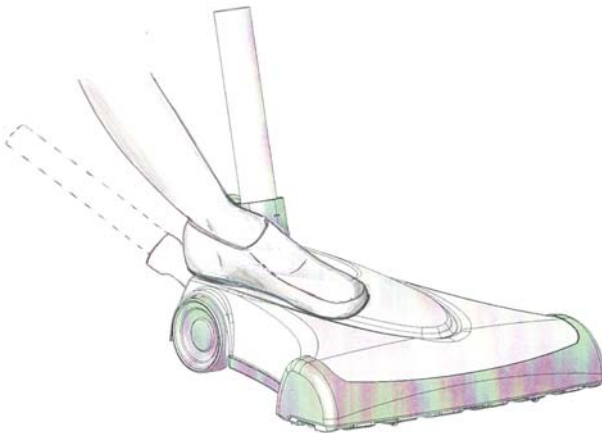

Use & Care of Your Turbine Powerhead

(B) OPERATING PROCEDURES

Your Turbine Powerhead runs off the airflow of your vacuum system. It has no on/off switch. Whenever it is attached to an operating vacuum system, it will be running. No adjustments to the powerhead are necessary for different types of carpeting.

To ensure maximum efficiency of the Turbine Powerhead, make sure that any filters, bags and cleaning hoses in your vacuum system are clean and free of blockage.

Avoid picking up water or spilled liquid with your Turbine Powerhead. The vacuum system is designed for dry pick up only.

(C) CLEANING ROLLER BRUSH

Turn off vacuum system and disconnect Powerhead. Threads, string, carpet fiber, fuzz and similar items may become wound around the beater brush. These should be removed by unwinding them by hand or carefully cutting with scissors. Keeping the beater brush clean will maintain efficiency.

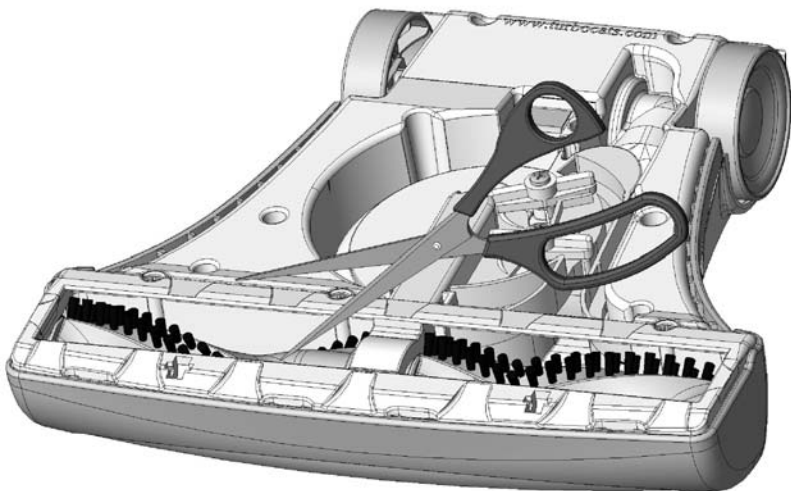

Use & Care of Your Turbine Powerhead

(D) REMOVING CLOGS

Follow these steps if the turbine becomes obstructed:

1. Turn off vacuum system and disconnect the Powerhead.
2. Remove the clear belt cover by turning the Powerhead over and rotating the two latches until they align with the openings in the belt cover. Remove the belt cover.
3. Remove debris from the intake or turbine. Rotate brush to ensure the system is clear. Ensure the orange seal on the belt cover and mating surfaces are clean before reinstalling the belt cover.
4. To reinstall the belt cover, simply insert the front of the belt cover under the baseplate edge and lower into its original position.
5. Secure the belt cover in place by turning the two latches to the locked position.

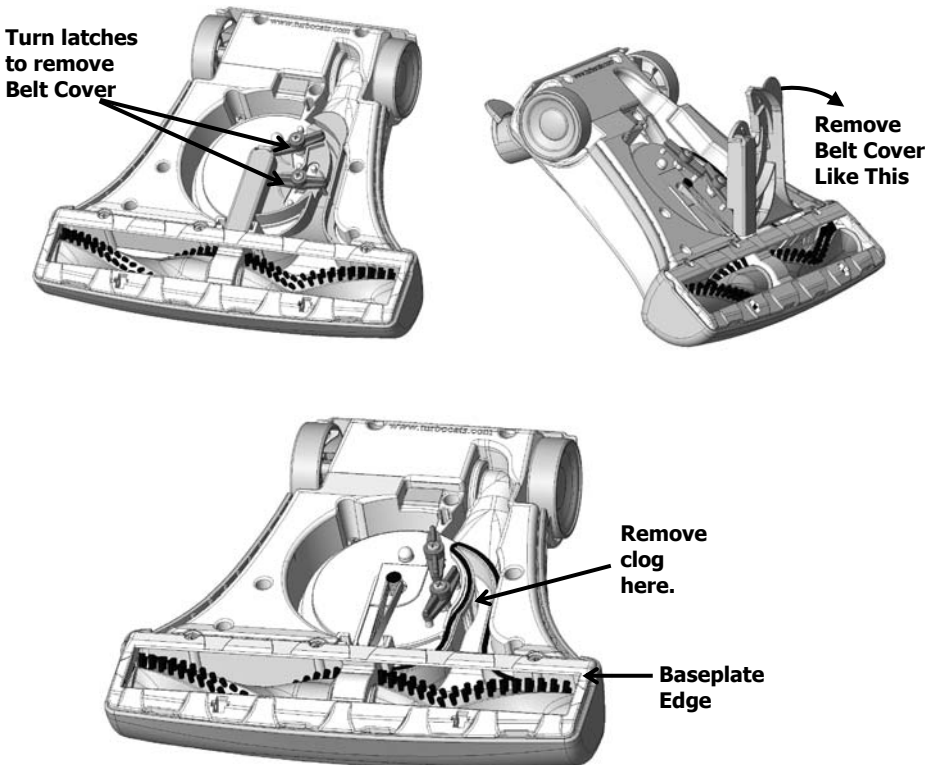

Use & Care of Your Turbine Powerhead

(E) REPLACING THE DRIVE BELT

It is recommended that the drive belt be replaced by a Qualified Service Technician.

1. Turn off vacuum system and disconnect powerhead.
2. Remove belt cover as described on page 4.
3. Remove the 3 screws securing the baseplate.
4. Remove the baseplate.
5. **IMPORTANT:** Please note correct brush and belt orientation. They must be be reinstalled correctly for proper function.
6. Lift the brush, belt and support assembly out of the housing.
7. Remove the old belt.
8. Place the new belt over one end, onto the brush roller, between the two center flanges.
9. Loop belt around shaft. Twist belt as shown.
10. Slide the brush/belt assembly back into the housing recesses so the supports seat properly into the housing. The assembly is designed to fit only one way into housing. **NOTE: The brush will rotate in the wrong direction if the belt is twisted incorrectly.**
11. Replace belt cover.

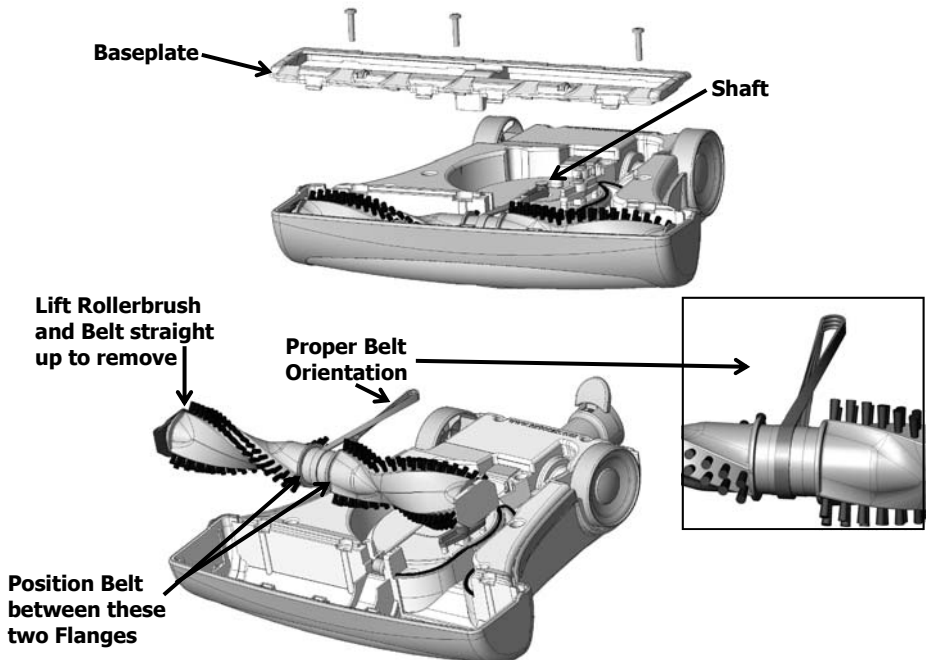

TROUBLESHOOTING THE TURBINE POWERHEAD

CAUTION: Moving parts—disconnect from vacuum system before servicing unit.

Use the chart below to troubleshoot common problems you may experience with your turbine powerhead. If you cannot solve the problem using the solutions below, please contact your distributor or dealer for service.

	Turbine Runs Slow	Brush Bounces in Use	Brush Hard to Push
Check for clog at air intake.	●		
Clean central vac power unit guard screen/filter.	●		
Check for clog in hose.	●		
Check for clog in tube line	●		
Ensure belt orientation is correct.			●
Change direction you are vacuuming.		●	

OTHER REPAIRS

For repairs or service beyond those described in this manual, please contact your servicing distributor or dealer. Visit www.turbocats.com for servicing dealer contact information.

LIMITED WARRANTY

H-P PRODUCTS, INC. warrants that the turbine powerhead when used for household purposes, pursuant to Seller's instructions, will be free from defects in materials and workmanship for a period of three(3) years from the date of the initial consumer purchase. H-P PRODUCTS, INC. warrants that the turbine powerhead, when used in a commercial application pursuant to Seller's instructions, will be free from defects in materials and workmanship for a period of ninety (90) days from the date of the initial consumer purchase. This warranty is limited to the replacement of defective parts and any costs of shipping shall be incurred by the purchaser. THIS WARRANTY IS EXCLUSIVE AND IS IN LIEU OF ALL OTHER WARRANTIES, EXPRESS, IMPLIED, OR STATUTORY, AND H-P PRODUCTS, INC. SPECIFICALLY DISCLAIMS RESPONSIBILITY FOR CONSEQUENTIAL AND INCIDENTAL DAMAGES, AND LIMITS THE IMPLIED WARRANTY OF MERCHANTABILITY TO THE PERIOD OF EFFECTIVENESS OF THIS EXPRESS WARRANTY.

H-P PRODUCTS, INC.
Louisville, Ohio 44641
U.S.A.
(330) 875-5556

REPLACEMENT PARTS

#	Description	Part #
1	Lower Housing	8412*
2	Wheel Assembly (2)	8425*
3	Turbine Assembly	8558
4	Belt Cover	8413
5	Base Plate	8414*
6	Compression Spring	8557
7	Washer, Spring	5974
8	Washer, Neck	5971
9	Neck Assembly	8423
10	Spring, Neck Lock	7218
11	Top Housing	8411*
12	Seal, Small	7223
13	Roller Brush Assembly	8457

#	Description	Part #
14	T-Latch (2)	7226
15	Belt	8439
16	Screw, Housing (12)	7228
17	Screw, T-Latch (2)	7230
18	Bearing, Idler Assembly	8556
19	Bushing, Wheel (2)	8415
20	Shaft Support Assembly, Left	8428
21	Shaft Support, Right, with washer	8561
22	Ballast (2)	7238
23	Foam Pad (4)	7239
24	Shaft, Roller Wheel (2)	8416
25	Roller Wheel (2)	8417
26	Bearing Isolator (2)	8427
27	Retaining Ring (2)	8458
28	Seal, Belt Guard, Large	7224

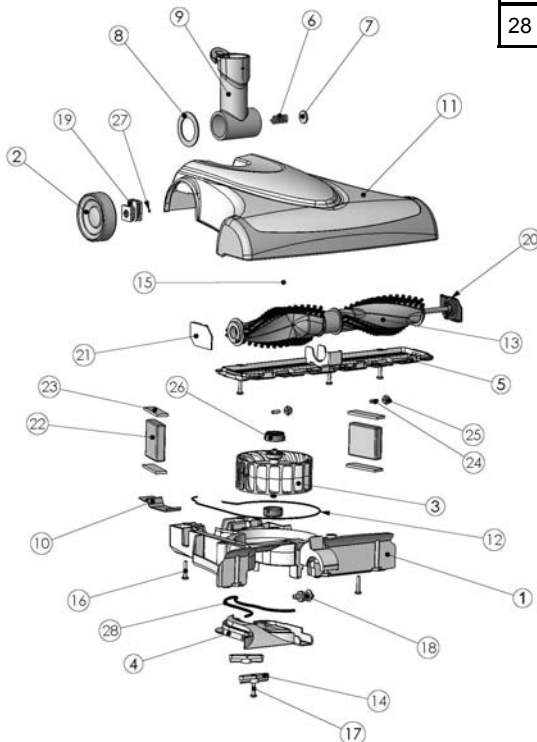

* Please specify color when ordering.